

The ISL6224 single PWM controller delivers high efficiency and tight regulation from a voltage regulating synchronous buck DC/DC converter. The ISL6224 PWM power supply controller was designed especially for chip set and memory bank applications in high performance notebook PCs, sub-notebook PCs, and PDAs. The MOSFET drivers, output voltage monitoring, output current monitoring, and protection circuitry are included in a single 16 lead SSOP package. The ISL6224EVAL1 evaluation board reference design provides an efficient, cost effective and compact power solution.

High efficiency is maintained over a wide load range through automatic selection of fixed frequency PWM synchronous rectification mode, also known as continuous conduction mode (CCM), or hysteretic diode emulation mode (HYS). The IC enters CCM in response to heavy loads and (HYS) mode in response to light loads, boosting efficiency. Forced CCM (FCCM) disables hysteretic mode. Efficiency is further enhanced by using the converters lower MOSFET $R_{DS(ON)}$ as a current sense element. Voltage feed-forward duty-cycle ramp modulation, average current mode control, and internal feedback compensation provide fast response to input voltage transients and output load transients.

The ISL6224 features output voltage adjustable in the range from 0.9V to 5.5V and a selectable switching frequency of either 300kHz or 600kHz. When operated from battery voltages ranging from 4V to 24V, a switching frequency of 300kHz is recommended. When operating from 5V, a switching frequency of 300kHz may be used or, to reduce the size of the output filter, 600kHz may be used.

Quick Start Evaluation

Circuit Setup

The ISL6224EVAL1 board is designed for easy evaluation using standard laboratory equipment. Refer to Table 2 for the range of input and output voltages and currents.

Switch Settings

The ISL6224EVAL1 board is shipped with the four position dip switch S1 set for 2.5V output. S1 controls the ENABLE function "EN" and selects the output voltage. Figure 1 illustrates S1 position names and Table 1 describes the function of each switch position.

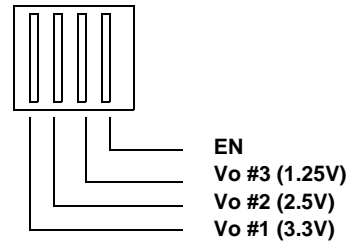

FIGURE 1. SWITCH S1 BIT POSITION NAMES

TABLE 1. SWITCH S1 FUNCTIONAL DESCRIPTION

POSITION	STATE	FUNCTION
EN	UP	ENABLES CONVERTER
	DOWN	DISABLES CONVERTER
Vo #1	UP	3.3V OUTPUT SELECTED
	DOWN	3.3V OUTPUT DESELECTED
Vo #2	UP	2.5V OUTPUT SELECTED
	DOWN	2.5V OUTPUT DESELECTED
Vo #3	UP	1.25V OUTPUT SELECTED
	DOWN	1.25V OUTPUT DESELECTED

NOTE: If Vo #1, Vo #2 and Vo #3 switches are all down, then the output voltage of the converter will be equal to Vref, which is 0.9 V. Only one voltage selection switch is UP at any time.

Jumper Settings

Jumper JP1 enables or inhibits hysteretic mode. If the shunt jumper is installed across the two pins located on the left, the IC will be allowed to operate in hysteretic mode, should the need arise. If the shunt jumper is installed across the two pins located on the right, the IC will be forced into continuous conduction mode. The evaluation board comes set for hysteretic mode.

Jumper JP2 selects the optimum duty cycle ramp gain and switching frequency. Jumper JP2 has three different positions each of which will have one side of the shunt jumper connected to the pin labeled "U3p1". Refer to Table 2 for the recommended jumper position. The ISL6224EVAL1 board is shipped with JP2 in the "5V 300kHz" position.

JP3 is used to measure the current (ICC) drawn by the VCC pin from the 5V power supply. When making efficiency measurements that include VCC, be sure to measure ICC from JP3. A substantial current is drawn by the red and green LED and should not be included in determining the efficiency of the converter.

TABLE 2. EVALUATION BOARD INPUT/OUTPUT REQUIREMENTS

OPERATION MODE	INPUT VOLTAGE (V)	OUTPUT VOLTAGE (V)	MIN OUTPUT CURRENT (A)	TYPICAL OUTPUT CURRENT (A)	MAX OUTPUT CURRENT (A)
VIN 5-24V 300kHz	4 to 24	0.9 to 5.5	0	2	3
VIN 5V 300kHz	5	0.9 to 3.3	0	1	2
VIN 5V 600kHz	5	0.9 to 3.3	0	1	2

Connect the Input Power Supplies

- Connect a 1AMP, 0 to +5VDC Power Supply as follows:
 - Before connecting to the evaluation board, turn on the power supply and adjust the output to +5V then turn off.
 - Power Supply positive terminal to the VCC post (J7).
 - Power Supply negative terminal to the GND post (J6).
- Connect a 5AMP, 0 to +24VDC Power Supply as follows:
 - Before connecting to the evaluation board, turn on the power supply and adjust the output to +5V then turn off.
 - Power Supply positive terminal to the VIN post (J2).
 - Power Supply negative terminal to the GND post (J8).

Connect the Output Load

- Connect a 5AMP Electronic Load as follows:
 - Electronic Load positive terminal to the VOUT post (J4).
 - Electronic Load negative terminal to the GND post (J3).

Operation

Examine Start-up Waveforms

NOTE: VIN MUST BE TURNED ON BEFORE VCC IN ALL CASES

Turn on the VIN power supply and the VCC power supply. Move the EN bit of S1 to the UP position. The start up sequence may be observed by using an oscilloscope. In Figure 2 the voltage on the SOFT pin of the IC, the output voltage at TP5, the power good signal at TP3, and the voltage of the enable signal at post J12 show typical waveforms. The voltage on the SOFT pin of the IC is produced by a 5 μ A current source charging a user supplied capacitor. The ramp time of the soft start voltage is controlled by the value of the charging capacitor. The output voltage follows the soft-start voltage. The green LED will illuminate when the output is within 10% of the nominal value. If the EN bit of switch S1 is moved to the DOWN position the LED will be red, indicating the converter is off. When a fault condition occurs the LED will be RED even though the EN bit of S1 is in the UP position. The fault latch may be cleared by turning the VCC power supply off, then on again.

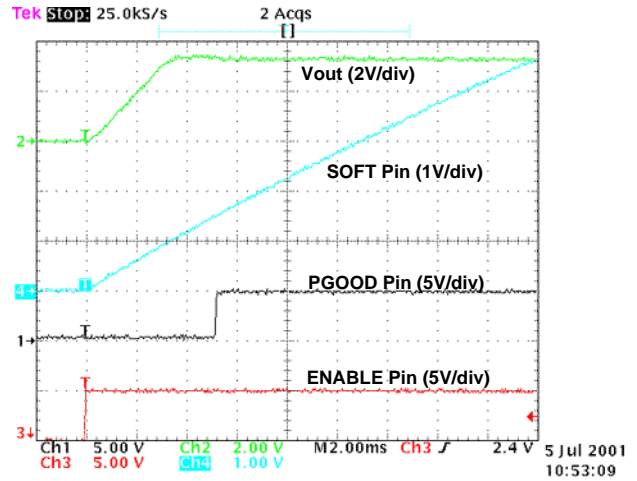

FIGURE 2. SOFT-START ON 3.3V OUTPUT (2ms/Div)

Output Ripple

The ISL6224EVAL1 evaluation board is populated with one 330 μ F/6.3V SANYO POSCAP output capacitor which has 40m Ω ESR at 100kHz. Figures 3 to 8 show the output voltage ripple and phase node voltage when the converter is operating in various modes and various combinations of VIN and Fs. Please see the ISL6224 data sheet for detailed instructions on how to select the output capacitor.

Transient Response

The transient response of the converter is the time interval ΔT required to slew the inductor current from an initial value to a final value such that the output voltage stays constrained within a specified range. The inductor ripple current affects the transient response performance. Figures 9 to 14 show the transient performance of the evaluation board.

NOTE: In following figures; CH1: Vout = 2.5 V, AC coupled.

Evaluation Board Performance Graphs

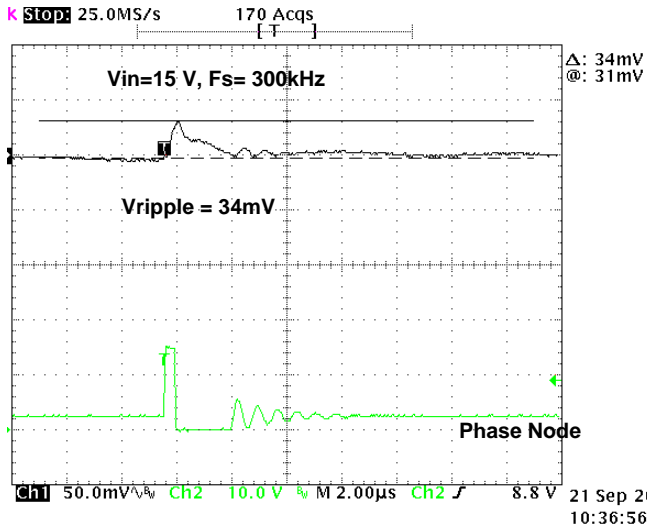

FIGURE 3. HYSTERETIC MODE AT ZERO LOAD CURRENT

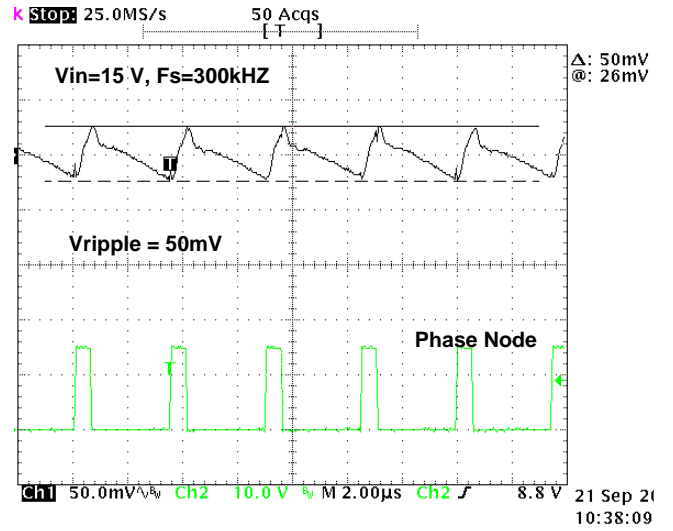

FIGURE 4. PWM MODE AT FULL LOAD CURRENT

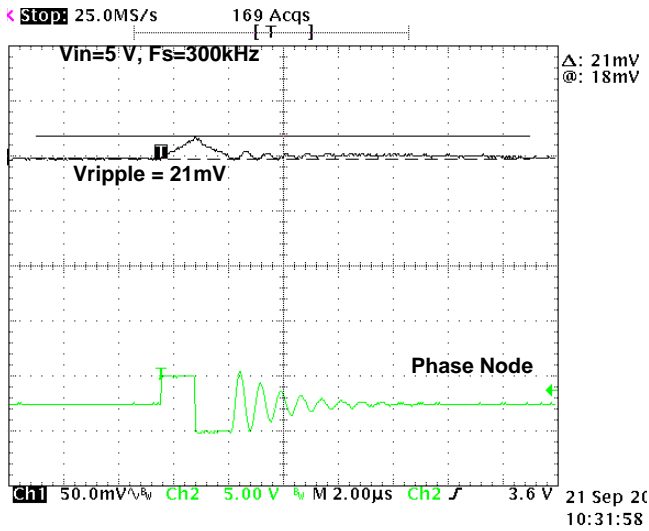

FIGURE 5. HYSTERETIC MODE AT ZERO LOAD CURRENT

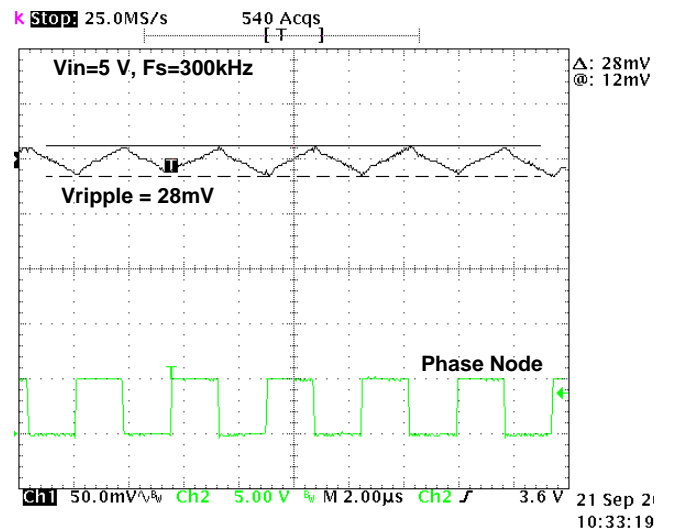
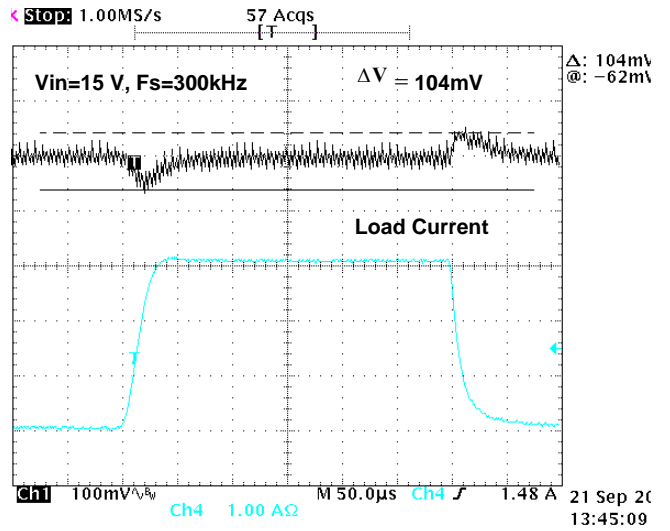
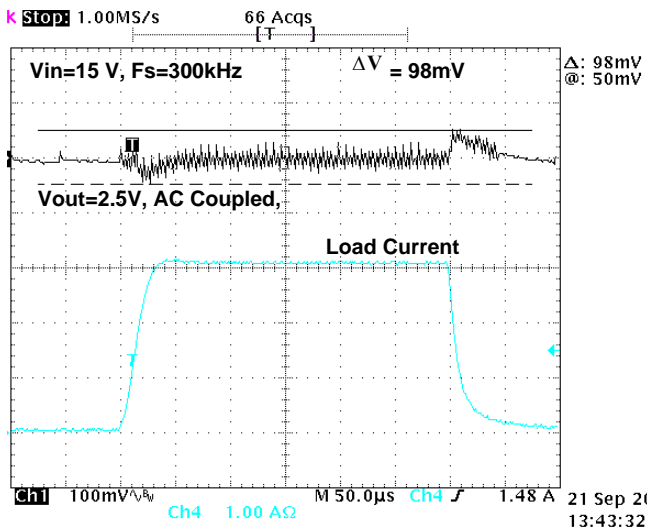
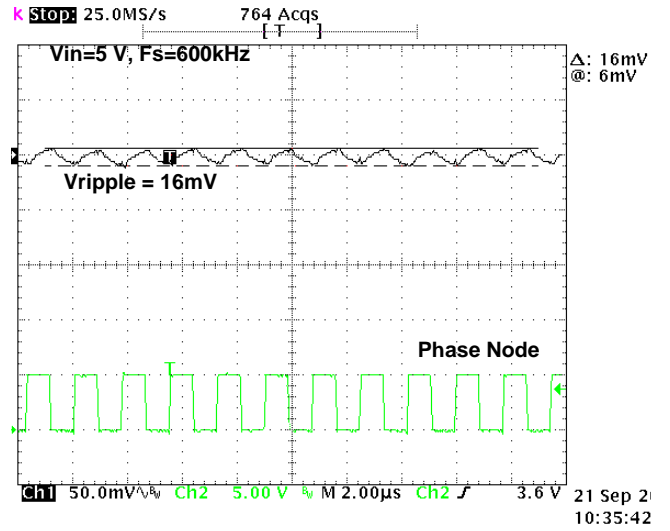
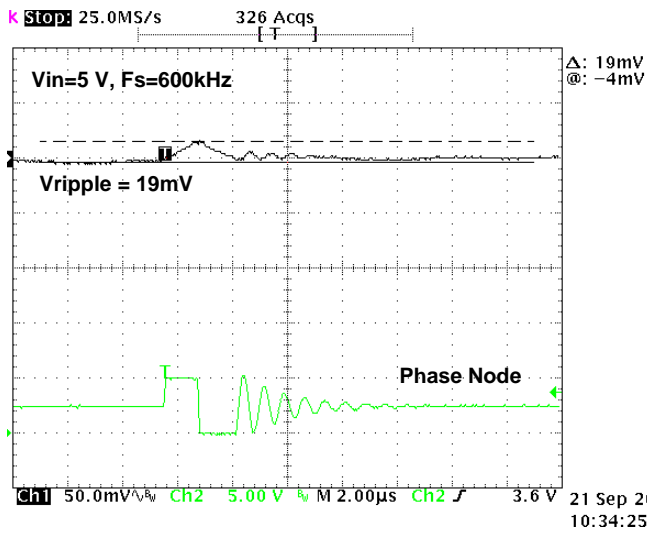

FIGURE 6. PWM MODE AT FULL LOAD CURRENT

Evaluation Board Performance Graphs (Continued)



Evaluation Board Performance Graphs (Continued)

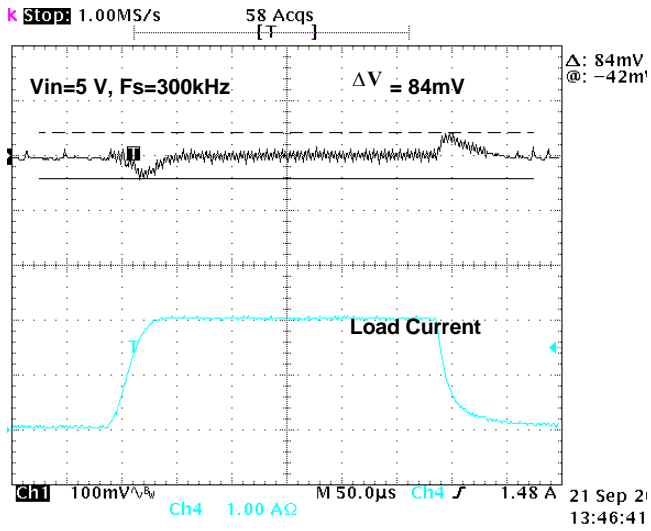

FIGURE 11. HYSTERETIC MODE TRANSIENT RESPONSE

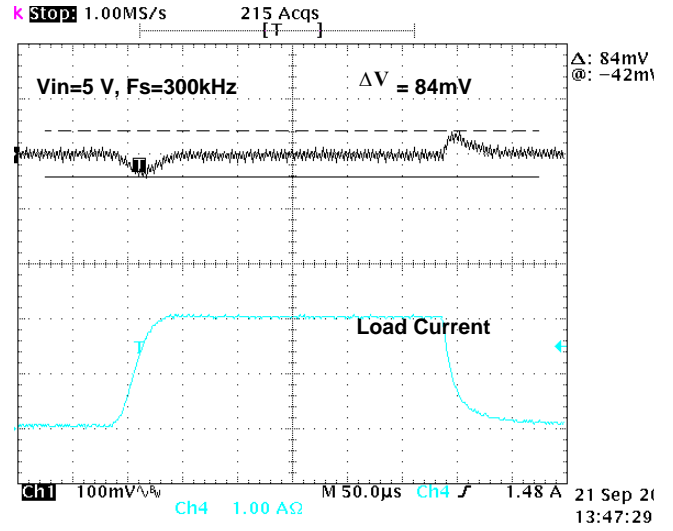

FIGURE 12. PWM MODE TRANSIENT RESPONSE

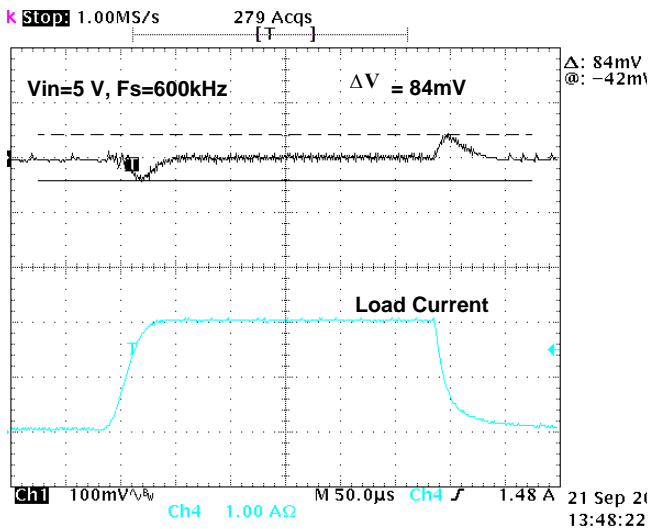

FIGURE 13. HYSTERETIC MODE TRANSIENT RESPONSE

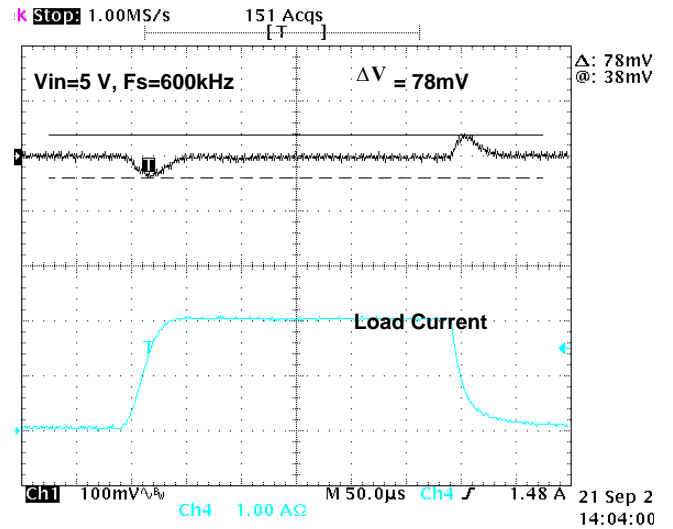

FIGURE 14. PWM MODE TRANSIENT RESPONSE

Over Current Protection

The ISL6224 monitors the converter output current by measuring the voltage developed across the $R_{DS(ON)}$ of the lower MOSFET and feeding it into the Isense pin through a scaling resistor. The current detection is used by the average current mode control loop and by the over current detection circuit. The scaling resistor is chosen such that it will flow $75\mu A$ of current when the converter is delivering full load current. It is important to understand that the current detected by the Isense pin is the sum of the DC AMPS at the output of the converter and the positive peak of the inductor ripple current. On page 9 of the ISL6224 data sheet is the formula to calculate the expected peak to peak inductor ripple current for a particular combination of VIN, VOUT, switching frequency, and output choke inductance. The value of "Iomax" is the sum of one half the calculated peak to peak inductor ripple current plus the value of the output full load current of the converter. The value of "Iomax" is now inserted into the Risen calculation on page 6 of the ISL6224 data sheet. The over current set point loc is typically set at 180% of "Iomax". The value of loc and the value of Risen are inserted into the Rocset calculation on page 6 of the ISL6224 data sheet. The ISL6224EVAL1 evaluation board has been adjusted for 3.0 full load amps and approximately 6.3A peak inductor current for over current protection. Figure 15 shows a typical shutdown waveform when the load is over the limit.

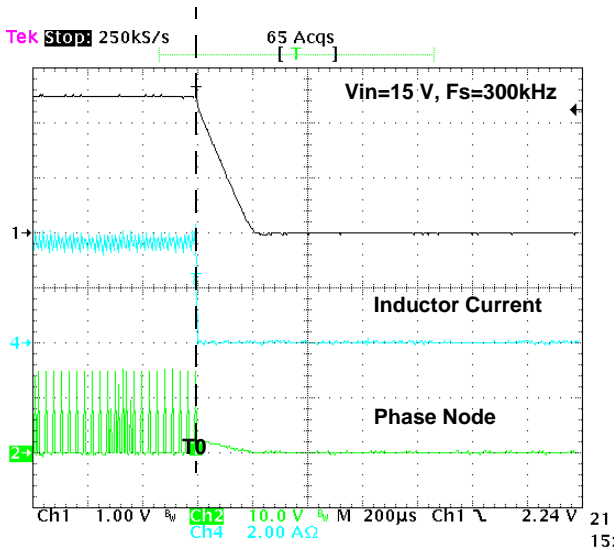

FIGURE 15. OUTPUT OVERLOAD SHUT DOWN

Efficiency

The ISL6224 evaluation was designed to use the lower MOSFETs $R_{DS(ON)}$ to increase efficiency. Figures 16 through 18 show the efficiency at various output currents and input voltages.

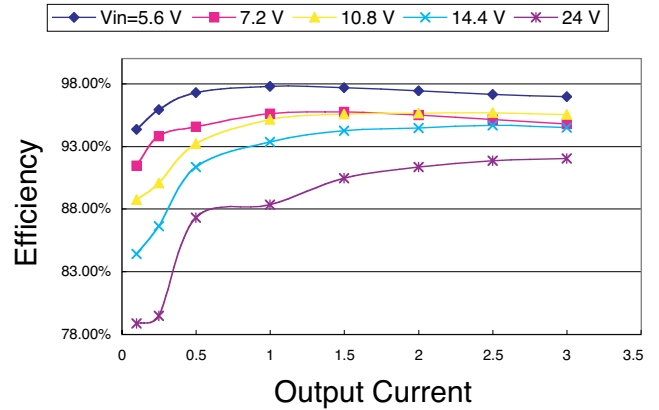

FIGURE 16. EFFICIENCY WHEN VOUT = 5V

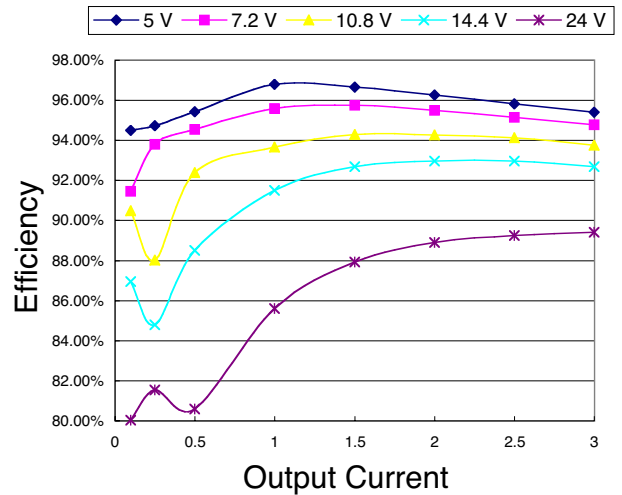

FIGURE 17. EFFICIENCY WHEN VOUT = 3.3V

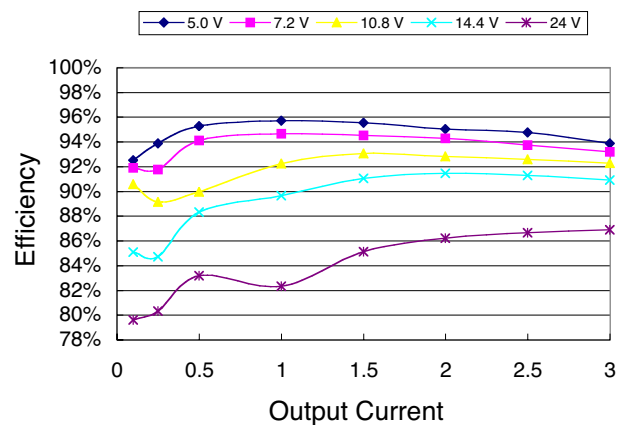

FIGURE 18. EFFICIENCY WHEN VOUT = 2.5V

Shutdown by Enable

When the EN bit of S1 is moved to the DOWN position the PWM stops and the inductor current decays to zero amps and the output capacitors discharge. A typical shutdown waveform is shown in Figure 19.

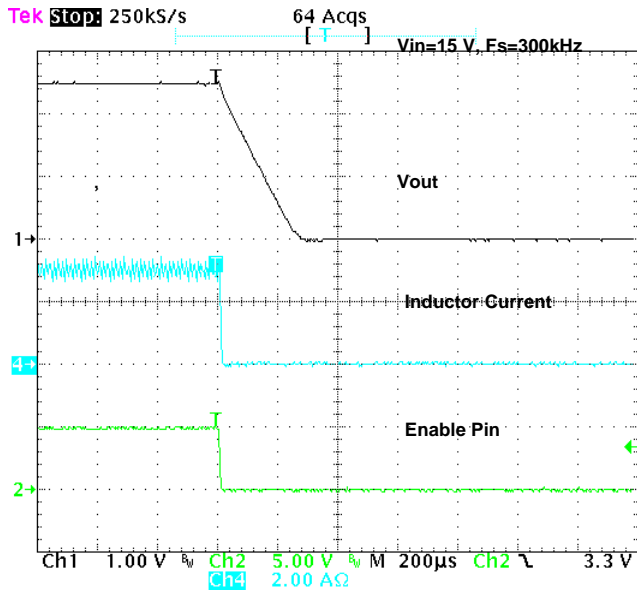

FIGURE 19. SHUT DOWN BY ENABLE PIN

Output Voltage Setpoint Calculation

The output voltage of the converter is set by connecting a two resistor voltage divider across the output. The feedback voltage divider output is connected to the VSEN pin of the IC. The voltage at the VSEN pin is 0.9V when the converter output is in regulation. The voltage at the VSEN pin is internally compared to a 0.9V reference voltage and passed on to the next stage of the PWM generation circuits. On the ISL6224EVAL1 evaluation board the two resistor voltage divider feedback network consists of R10 (top resistor) and (R15 or R16 or R17) bottom resistors. Each bottom resistor chooses a different output voltage. The resistors are selected by switch S1. The equation for the setpoint of the output voltage is shown below.

$$R_y = \frac{R_{10} \times V_{ref}}{V_o - V_{ref}}$$

Where R_y is bottom resistor, V_o is the required output voltage and V_{ref} is the reference voltage.

Some of the most popular output voltage setpoints are calculated in Table 3.

TABLE 3. OUTPUT VOLTAGE SETPOINT

V_o	1.25V	1.5V	2.5V	3.3V	5.0V
R10	11.8K	11.8K	11.8K	11.8K	11.8K
R_y	30.1K	17.8K	6.65K	4.42K	2.59K

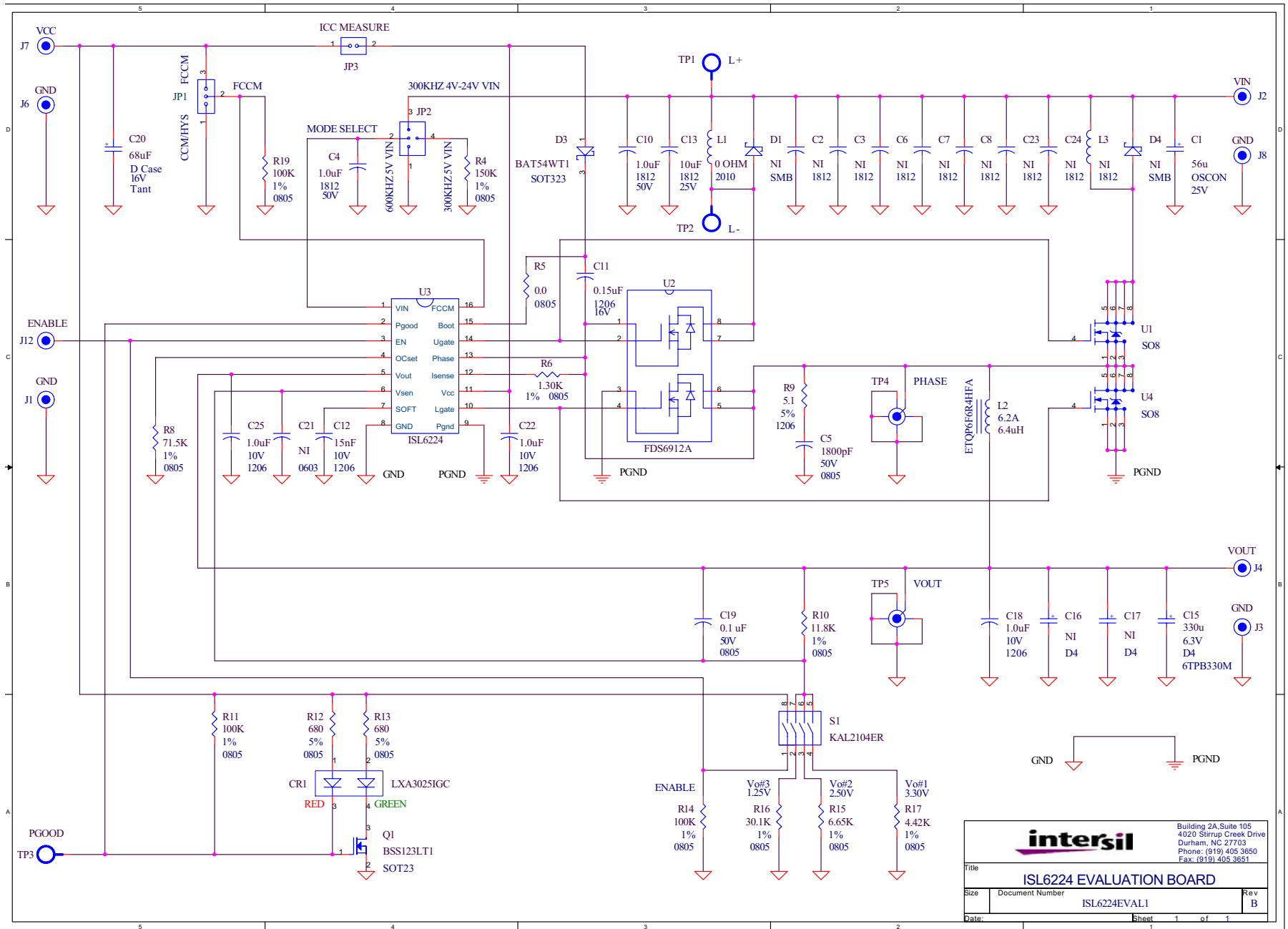

FIGURE 20. ISL6224EVAL1 EVALUATION BOARD SCHEMATIC

intersil		Building 2A, Suite 105 4020 Stirrup Creek Drive Durham, NC 27703 Phone: (919) 405 3650 Fax: (919) 405 3651	
ISL6224 EVALUATION BOARD			
Title	Document Number	ISL6224EVAL1	Rev B
Date	Sheet	1 of 1	

Application Note 9983

TABLE 4. BILL OF MATERIALS REV B FOR ASSEMBLY ISL6224EVAL1

ITEM	QTY	UNITS	REFERENCE DESIGNATOR	DESCRIPTION	MFG	PART NUMBER
1	1	ea	CR1	LED, SMD, 4P, POLARIZED, RED/GRN	LUMEX	SSL-LXA3025IGC-TR
2	1	ea	C1	CAP, OSCON, RADIAL, F-SIZE, 56μF, 25V, 20%	SANYO	25SP56M
3	1	ea	C13	CAP, X5R, 1812, 10μF, 25V, 20%	TAIYO YUDEN	CE-TMK432BJ106MM
4	2	ea	C4, C10	CAP, X7R, 1812, 1.0μF, 50V, 10%	KEMET	C1812C105K5RAC
5	1	ea	C5	CAP, X7R, 0805, 1800pF, 50V, 10%	KEMET	C0805C182K5RAC
6	1	ea	C11	CAP, X7R, 1206, 0.15μF, 16V, 10%	KEMET	C1206C154K4RAC
7	1	ea	C12	CAP, X7R, 1206, 0.015μF, 10V, 10%	KEMET	C1206C153K8RAC
8	3	ea	C18, C22, C25	CAP, X7R, 1206, 1.0μF, 10V, 10%	KEMET	C1206C105K8RAC
9	1	ea	C19	CAP, X7R, 0805, 0.1μF, 50V, 10%	KEMET	C0805C104K5RAC
10	1	ea	C20	CAP, TANT, D-CASE, 68μF, 16V, 20%	KEMET	T494D686M016AS
11	1	ea	C15	CAP, POSCAP, D4-CASE, 330μF, 6.3V, 20%	SANYO	6TPB330M
12	1	ea	D3	DIODE, SCHOTTKY BARRIER, SOT323, 30V, 200mA	ON SEMICONDUCTOR	BAT54WT1
13	1	ea	Q1	TRANSISTOR, MOSFET, N-CHANNEL, SOT23, 100V, 170mA	ON SEMICONDUCTOR	BSS123LT1
14	1	ea	U3	IC, PWM CONTROLLER, 24V, 16PIN, SSOP	INTERSIL	ISL6224CA
15	1	ea	U2	TRANSISTOR, MOSFET, N-CHANNEL, DUAL, LOGIC LEVEL, 30V, 6.0A	FAIRCHILD	FDS6912A
16	1	ea	L1	RESISTOR, Cu ALUMINA, 2010, 3.0 mΩ MAX, 30.0A	IRC	LRC-LRZ-2010-R000
17	1	ea	L2	INDUCTOR, PWR, SMD, 5.7mm, 6.4uH, 6.2A,	PANASONIC	ETQP6F6R4H
18	1	ea	R5	RESISTOR, TF, 0805, 0Ω, 125mW, 5%	PANASONIC	ERJ6GEY0R00V
19	1	ea	R4	RESISTOR, TF, 0805, 150K, 1/10W, 1.0%	PANASONIC	ERJ6ENF1503V
20	1	ea	R9	RESISTOR, TF, 1206, 5.1Ω, 250mW, 5%	PANASONIC	ERJ8GEYJ5R1V
21	1	ea	R10	RESISTOR, TF, 0805, 11.8K, 100mW, 1.0%	PANASONIC	ERJ6ENF1182V
22	3	ea	R11, R14, R19	RESISTOR, TF, 0805, 100K, 100mW, 1.0%	PANASONIC	ERJ6ENF1003V
23	2	ea	R12, R13	RESISTOR, TF, 0805, 680Ω, 125mW, 5%	PANASONIC	ERJ6GEYJ681V
24	1	ea	R15	RESISTOR, TF, 0805, 6.65K, 100mW, 1.0%	PANASONIC	ERJ6ENF6651V
25	1	ea	R16	RESISTOR, TF, 0805, 30.1K, 100mW, 1.0%	PANASONIC	ERJ6ENF3012V
26	1	ea	R17	RESISTOR, TF, 0805, 4.42K, 100mW, 1.0%	PANASONIC	ERJ6ENF4421V

Application Note 9983

TABLE 4. BILL OF MATERIALS REV B FOR ASSEMBLY ISL6224EVAL1 (Continued)

ITEM	QTY	UNITS	REFERENCE DESIGNATOR	DESCRIPTION	MFG	PART NUMBER
27	1	ea	R6	RESISTOR, TF, 0805, 1.30K, 100mW, 1.0%	PANASONIC	ERJ6ENF1301V
28	1	ea	R8	RESISTOR, TF, 0805, 71.50K, 100mW, 1.0%	PANASONIC	ERJ6ENF7152V
29	3	ea	TP1, TP2, TP3	TEST POINT, THRU HOLE, LOOP, WHITE	KEYSTONE	5002
30	2	ea	TP4, TP5	TEST POINT, THRU HOLE, SCOPE PROBE, COMPACT	TEKTRONICS	131-5031-00
31	8	ea	J1, J2, J3, J4, J6, J7, J8, J12	TERMINAL POST, THRU HOLE	KEYSTONE	1502-2
32	2	ea	JP1, JP2	HEADER, 1x3, THRU HOLE, 2.54mm PITCH	BERG/FCI	68000-236-1X3
33	1	ea	JP3	HEADER, 1x2, THRU HOLE, 2.54mm PITCH	BERG/FCI	68000-236-1X2
34	3	ea	JP1, JP2, JP3	SHUNT, TWO PIN, 2.54mm PITCH	SULLINS	SPC02SYAN
35	1	ea	S1	SWITCH, FOUR POSITION, SM	E-SWITCH	KAL2104R
36			C2, C3, C6, C7, C8, C16, C17, C21, C23, C24, D1, D4, L3, U1, U4	NO INSTALL		

Silk Screens

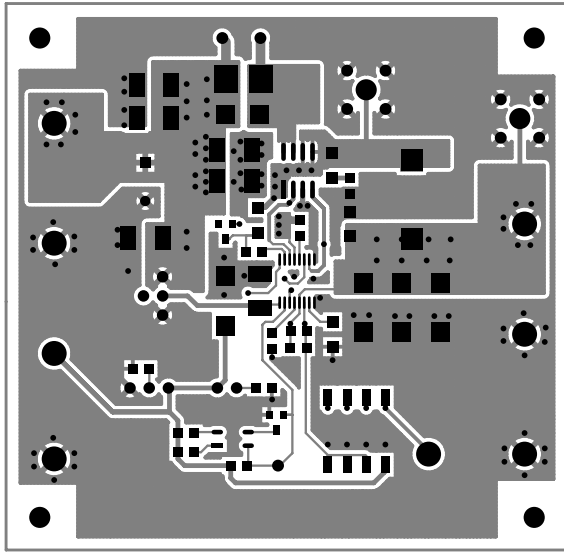

FIGURE 21. TOP LAYER

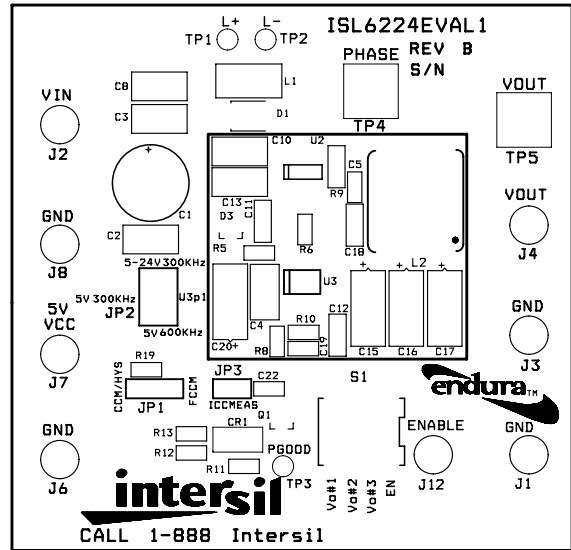

FIGURE 22. SILK SCREEN TOP

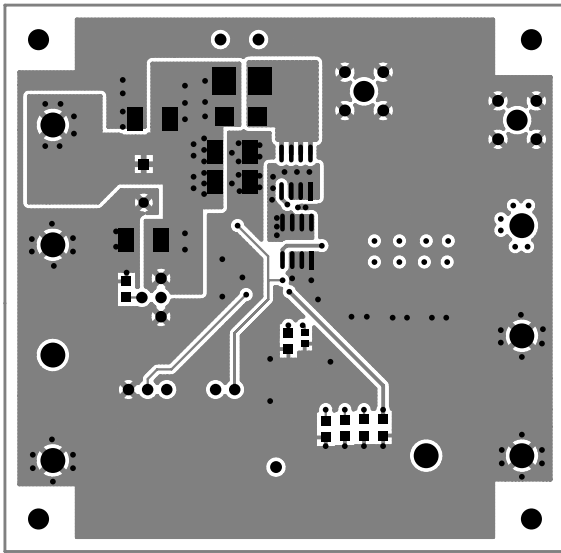

FIGURE 23. BOTTOM LAYER

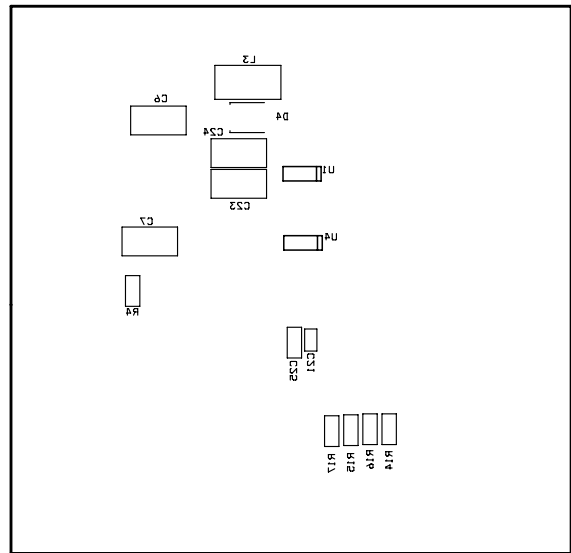

FIGURE 24. SILK SCREEN BOTTOM

Silk Screens (Continued)

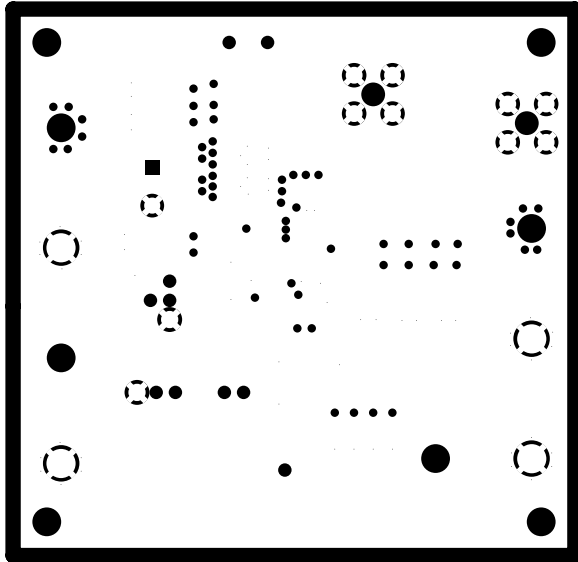

FIGURE 25. GROUND INTERNAL

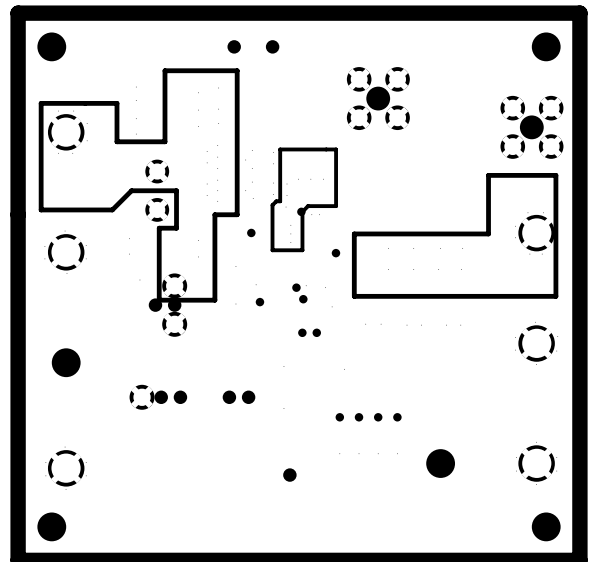

FIGURE 26. POWER INTERNAL

All Intersil U.S. products are manufactured, assembled and tested utilizing ISO9000 quality systems.
Intersil Corporation's quality certifications can be viewed at www.intersil.com/design/quality

Intersil products are sold by description only. Intersil Corporation reserves the right to make changes in circuit design, software and/or specifications at any time without notice. Accordingly, the reader is cautioned to verify that data sheets are current before placing orders. Information furnished by Intersil is believed to be accurate and reliable. However, no responsibility is assumed by Intersil or its subsidiaries for its use; nor for any infringements of patents or other rights of third parties which may result from its use. No license is granted by implication or otherwise under any patent or patent rights of Intersil or its subsidiaries.

For information regarding Intersil Corporation and its products, see www.intersil.com